



CA 08

Stud Welding Gun

92-20-255



Operating Manual



After-sales service for Germany:

HBS Bolzenschweiss-Systeme GmbH & Co. KG
Felix-Wankel-Straße 18
85221 DACHAU
GERMANY

Phone **+49 8131 511-0**
Fax **+49 8131 511-100**
E-mail **post@hbs-info.com**
Web **www.hbs-info.com**

CA 08 Operating Manual Issue 2016-10 Order No. E-BA 92-20-255

Translation of the Original Operating Manual

Please keep the manual in a safe place for future reference.

Transmission and duplication of this document, dissemination and notification of the contents are not permitted unless expressly approved.

All rights, errors and technical amendments reserved.

© HBS Bolzenschweiss-Systeme GmbH & Co. KG



Dear Customer,

Many thanks for buying a stud welding machine from HBS Bolzenschweiss-Systeme.

We at HBS wish you success at all times when working with this stud welding machine.

The high level of quality of our products is guaranteed by ongoing further development in the design, equipment and accessories. This may result in differences between the present operating manual and your product. No claims can therefore be derived from the data, illustrations and descriptions.

We have compiled the data and information in this reference work with the greatest care, and have made every effort to ensure that the information contained in this manual was correct and up-to-date at the time of delivery. We can nevertheless give no guarantee for an absolutely error-free document.

Should you discover any errors or unclear points when reading this operating manual, please do not hesitate to contact us.

We would also be grateful for any feedback should you have any suggestions or complaints to make about our product.

HBS Bolzenschweiss-Systeme GmbH & Co. KG

Felix-Wankel-Strasse 18

85221 Dachau

GERMANY



Table of Contents

1	Important Safety Precautions	6
2	Symbols and Terms Used	9
3	Scope of Supply	12
4	Accessories	12
5	Technical Data	13
6	Intended Use	14
7	Warranty	15
8	Design and Function	16
9	Welding Process	17
10	Preparing the Welding Gun	18
10.1	Adjusting the Chuck	18
10.2	Mounting the Chuck	21
10.3	Setting the Welding Parameters	22
	Adjusting Lift	26
	Adjusting Spring Force	27
11	Welding	28
12	Troubleshooting	29
13	Maintenance and Care	31
13.1	Cleaning	31
13.2	Inspection and Tests	32



14	Storage	33
15	Disposal	33
	Declaration of Incorporation of partly completed Machinery	34
	Service & Support	35
	Index	36

1 Important Safety Precautions

The target group for this manual are qualified personnel who in view of their technical training, know-how and experience and knowledge of applicable regulations are able to assess the work assigned to them and recognise potential hazards.



Danger from incorrect use

- ◆ Use the stud welding machine only for the purpose described in this manual.

Otherwise you may endanger yourself or damage the stud welding machine.

You endanger yourself and others if you operate the stud welding machine incorrectly or fail to observe the safety precautions and warnings. This can lead to serious injury or extensive material damage.



Danger for unauthorised operating personnel

- ◆ Work with the stud welding machine only when
 - You are appropriately trained, instructed and authorised to do so, and
 - You have read and completely understood this operating manual.
- ◆ Never work with the stud welding machine when you are under the influence of
 - Alcohol,
 - Drugs or
 - Medication.



Danger from unauthorised modifications

- ◆ Never modify the stud welding machine or parts thereof without obtaining a clearance certificate from the manufacturer.

You will otherwise endanger yourself. This can lead to serious injury or extensive material damage.



Life-threatening danger for wearers of active implanted cardiac devices

- ◆ Never operate the stud welding machine if you wear a heart pace-maker or implanted defibrillator.
- ◆ In this case, never remain in the vicinity of the stud welding machine during welding.
- ◆ Never operate the stud welding machine if persons with heart pace-makers or implanted defibrillators are in the vicinity.

Strong electromagnetic fields are produced in the vicinity of the stud welding machine during welding. These fields could impact the function of heart pacemakers or implanted defibrillators.



Danger from fumes and airborne particulates

- ◆ Switch on the welding fume extractor at the place of work.
- ◆ Ensure that the room is well ventilated.
- ◆ Never weld in rooms with a ceiling height of less than 3 m.
- ◆ Observe furthermore your working instructions and the accident prevention regulations.

This will help to avoid health damage due to fumes and airborne particulates.



Danger from glowing metal spatter (fire hazard)

Glowing hot weld spatter and liquid splashes, flashes of light and a loud bang > 90 dB (A) must be anticipated during stud welding.

- ◆ Inform colleagues working in the immediate vicinity accordingly before starting work.
- ◆ Ensure that an approved fire extinguisher is available at the workplace.



- ◆ Do not weld when wearing working clothes soiled with flammable substances such as oil, grease, petroleum, etc.
- ◆ Wear your proper protective clothing, such as:
 - Protective gloves in accordance with the relevant standard,
 - Non-flammable clothing,
 - A protective apron over your clothing,
 - Full-ear hearing protection in accordance with the relevant standard,
 - A safety helmet when welding above your head,
 - Safety shoes,
 - Safety goggles with sight glass of protection level 2 in compliance with the applicable standards and do not look directly into the light arc.
- ◆ Remove all flammable materials and liquids from the vicinity of the work area before starting welding.
- ◆ Weld at a safe distance from flammable materials or liquids. Select a safety distance large enough to ensure that no danger can arise from weld spatter.



Protection of the stud welding unit

- ◆ Protect the stud welding machine against the ingress of foreign matter and liquids caused by cutting or grinding work in the vicinity of your work area.

This will help to prolong the service life of your stud welding machine.

2 Symbols and Terms Used

The symbols used in this operating manual have the following meanings:



Danger

Warns you of hazards that can lead to **injury of persons** or to **considerable material damage**.



Caution

Problems with the operating procedures **can occur** if this information is **not observed**.



No access for people with active implanted cardiac devices



Danger

Warns you of **electrical** hazards



Danger

Warns you of **electromagnetic fields** that can be generated during welding



These symbols prompt you to wear **personal protective clothing when working with the stud welding unit**.



This symbol prompts you to wear **ear protection**. **A loud bang > 90 dB (A)** can occur during the welding process.



Tip

Cross-reference to useful information on the use of the stud welding machine



Cross-references in this operating manual are marked with this symbol or *are printed in italics*



Fire hazard

Have a suitable fire extinguisher for the working area ready before starting work.



Work instruction



List

Glossary

Automatic welding head:	Device for welding of welding elements
Capacitor:	Component for storage of electrical energy.
Light arc:	Independent gas discharge between two electrodes when the current is high enough. A whitish light is emitted in the process. The light arc allows very high temperatures to be generated.
Rectifier:	Electrical component that converts alternating voltage into direct voltage
Stud feeder:	Device for automatic feeding of welding elements
Stud welding gun:	Device for welding of welding elements
Stud welding machine:	Stud welding unit including stud welding gun
Stud welding unit:	Device for provision of the electrical energy for stud welding
Thyristor:	Electronic component for contact-free switching of high currents; switching takes place via the control input
Welding element:	Component such as stud or pin that is welded to the workpiece
Welding parameters:	Mechanical and electrical settings at the stud welding gun and at the stud welding unit (e.g. spring force, charging voltage)
Workpiece:	Components such as sheet metal or tubes to which the welding elements are to be fastened

3 Scope of Supply

The **basic configuration** of your welding gun contains the following parts:

No. of pieces	Part	Type	Order No.
1	Welding gun cable length 3 m	CA 08	92-20-255
1	Operating manual	CA 08	E-BA 92-20-255
1	Socket wrench	AF 17	80-40-085

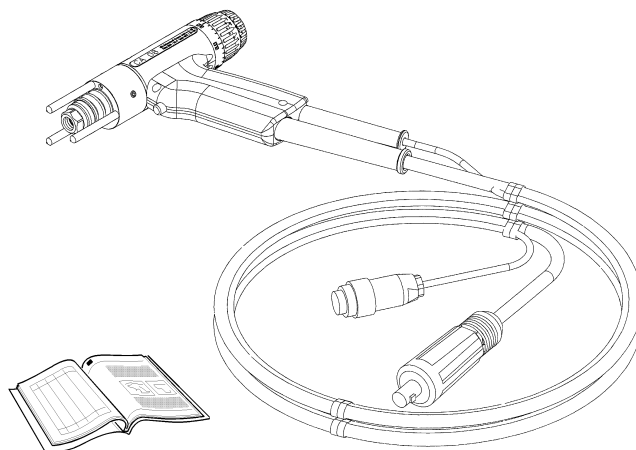

- ◆ Inspect the shipment for visible damage and completeness immediately on receipt.
- ◆ Report any transport damage or missing components immediately to the delivering shipping agent or the dealer (address, see page 2).

4 Accessories

For example:

Set of CD chucks (3 up to 8 mm and socket wrench)	92-40-018
Protective hose, complete with zipper	80-11-230

Additional accessories can be found in our extensive accessories catalogue.

5 Technical Data

Stud welding gun Type CA 08

for CD and ARC stud welding according to current standards

Welding range	M3 to M8, dia. 2 to 8 mm (other dimensions on request)
Stud length	6 to 40 mm, longer studs can be welded with optional accessories
Stud material	Mild steel, stainless steel, aluminium, brass
Stud type	Any type or shape (special chucks if required)
Lift	Adjustment range 4.5 mm, lockable
Spring force	Adjustable, arresting
Welding cable	3 m
IP-Code	IP 20 (protect against humidity)
Workplace noise level	> 90 dB (A) may occur during welding
Ambient temperature limits	0 °C to 40 °C
Dimension L x W x H	190 x 40 x 140 mm (without cable)
Weight	0.7 kg (without cable)



6 Intended Use

The stud welding gun has been designed exclusively for use with standardised stud welding elements. The use of any other elements will result in the desired strength of the welded joint being diminished.

The stud welding gun must only be connected to HBS stud welding units.

- ◆ Always check with the operating manual of your stud welding unit whether this stud welding gun may be used.

Observation of the operating manual of the stud welding unit being used is also part of the intended use.

7 Warranty

Please refer to the latest "General Terms and Conditions" for the scope of the warranty.

The warranty does not cover faults caused by e.g.

- Normal wear,
- Improper handling,
- Failure to observe the operating manual,
- Failure to observe the safety precautions,
- Use for other than the intended purpose, or
- Transport damage.

Warranty entitlement shall no longer be valid if modifications, changes or service and repair work is carried out by unauthorised persons or without the knowledge of the manufacturer. Invalidation of warranty entitlement shall also render the declaration of conformity invalid. The CE marking shall be declared invalid by the manufacturer.

We expressly point out that only spare parts and accessories or components approved by us may be used. The same applies likewise to installed units from our sub-suppliers.

8 Design and Function

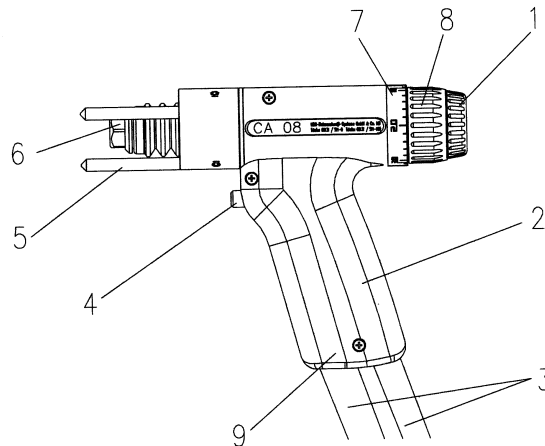

The body of the stud welding gun consists of a sturdy two-part **plastic housing (2)**.

The **control cable** and the **welding cable (3)** are connected through the welding gun handle to the welding gun.

At the front of the welding gun handle, the **welding gun trigger (4)** is installed. It is used to trigger the welding process.

At the front of the welding gun, the foot ring is installed. Three **legs (5)** can be used to position the welding gun straight.

Positioned at the front of the welding gun are the welding piston and the **retaining nut (6)** used to fix the manual chuck.

At the rear, there is the mechanism for **lift adjustment (8)**, rotating **graduated ring (7)** and for **spring force adjustment (1)**.

The **serial number (9)** can be found on the welding gun handle.

Type plate

The type plate contains the following information:

- Manufacturer
- Type

The serial number is stamped.

9 Welding Process

This welding gun may only be used for the following welding processes:

- Capacitor discharge stud welding with tip ignition and
- Drawn arc stud welding (short-cycle drawn arc welding).

Please refer to the original operating manual of the connected power unit for the welding procedure.

10 Preparing the Welding Gun

Prepare the welding gun by

- adjusting the chuck
- mounting the chuck
- adjusting lift and spring force.



◆ **Do not connect the gun to the stud welding unit until it has been prepared.**

In this way you can avoid any unintentional starting of the welding process.

10.1 Adjusting the Chuck

◆ Select a chuck suitable for your welding element.

for CD stud welding:

Threaded studs PT and PS



Stud dimension		Chuck
Ø	Length in mm	
M3	6 - 30 mm	82-50-003
M4	6 - 40 mm	82-50-004
M5	8 - 45 mm	82-50-005
M6	8 - 55 mm	82-50-006
M8	10 - 40 mm	82-50-008



Pins UT and US



Stud dimension		Chuck
Ø in mm	Length in mm	
3	6 - 25 mm	82-50-003
4	6 - 25 mm	82-50-004
5	6 - 40 mm	82-50-005
6	8 - 50 mm	82-50-006
7.1	10 - 40 mm	82-50-071



Pins IT and IS



Stud dimension		Internal thread	Chuck for studs with internal thread
Ø in mm	Length in mm		
5	6 - 35 mm	M3	82-50-905
6	8 - 35 mm	M4	82-50-906
6	8 - 35 mm	M5	82-50-906
7.1	10 - 35 mm	M5	82-50-971
8	10 - 35 mm	M6	82-50-908



Ground clips (single and double style)



Dimension
 \varnothing in mm
 6.3 6 - 40 mm

Chuck
 82-50-050



- ◆ Stick the welding element into the chuck. An adjustable stop pin is located in the chuck.
- ◆ Disconnect the lock nut.
- ◆ Rotate the stop pin in the chuck so that

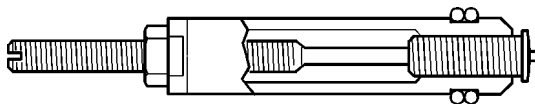

– for welding elements up to 20 mm long, the non-threaded part is in the chuck.

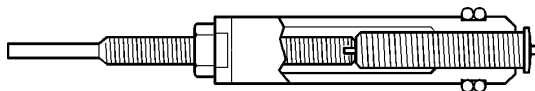

– for welding elements over 20 mm long, the non-threaded part sticks out of the chuck.



For welding elements with internal threads or chucks for internal threaded studs, a special stop pin accessory for internal threads can be delivered.

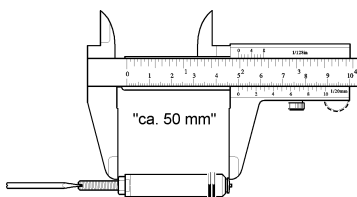
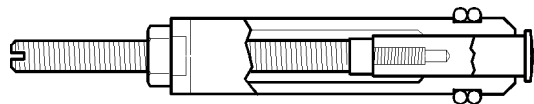

- ◆ Adjust the stop pin so that the overall measurement value from the top of the lock nut to the bottom of the welding element is between 50 and 51 mm.

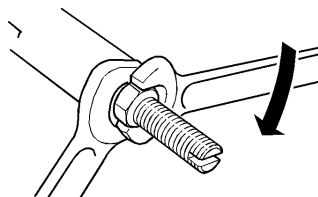

- ◆ Screw the lock nuts back on.

for welding elements for special applications:

Bimetallic insulation pins



Dimension		Chuck
Ø in mm	Length in mm	
6	50 - 80 mm	80-04-959



For welding of bimetallic insulation pins the ISO leg assembly PSI-2 with 3 legs (Order No. 92-40-043) without plastic insertion is necessary.

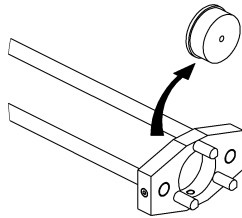

- ◆ Stick the welding element into the chuck. An adjustable stop pin is located in the chuck.
- ◆ Disconnect the lock nut.
- ◆ Rotate the stop pin in the chuck so that

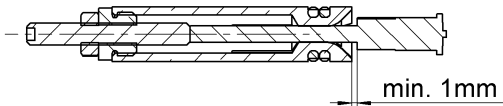

– the aluminium sleeve of the bimetallic insulation pin sticks out of the chuck at least 1 mm.

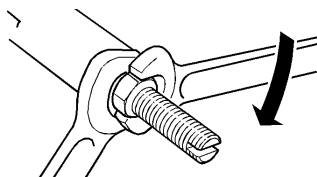

- ◆ Screw the lock nuts back on.



The insertion depth is adjusted via the leg assembly:

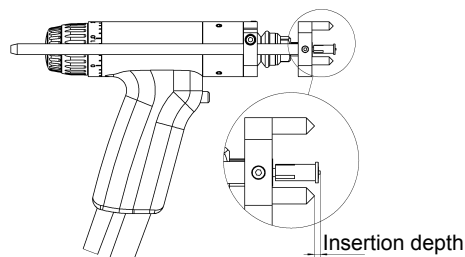

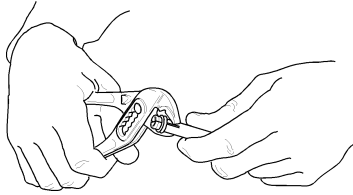

- ◆ Carefully retighten the chuck on the four fins with pliers at regular intervals.

This ensures good current conduction. This prevents premature wear due to spark erosion.

10.2 Mounting the Chuck

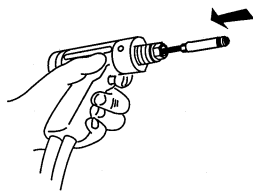

- ◆ Loosen the retaining nut on the piston of the welding gun.
- ◆ Stick the chuck into the piston up to the stop block.

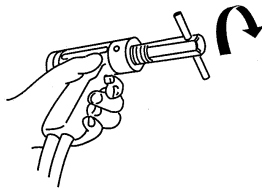

- ◆ Tighten the retaining nut again with the 17 mm socket wrench.
- ◆ When doing so, make sure the bellows are correctly positioned.



10.3 Setting the Welding Parameters

The lift and spring force are, among others, dependent on the workpiece and welding elements used and their diameters.

The specifications in the following table are guidelines.

- ◆ Select the applicable parameters for lift and spring force for your workpiece.

Stud welding units			CD 1501 CDi 1502	CD 2301 CDi 2302	CD 3101 / CDi 3102 CDM 2401 CDMi 2402 CDM 3201 CDMi 3202 SCD 3201	SC-Mode without shielding gas				
Material of welding elements	Diameter of welding elements metrisch		Welding gun parameters ¹⁾ CA 08							
	PT, UT	IT	Spring force (scaling)	Lift (mm)	Spring force (scaling)	Lift (mm)	Spring force (scaling)	Lift (mm)	Spring force (scaling)	Lift (mm)
Material of workpiece: Mild steel (suitable for welding)										
4.8 (suitable for welding)	M3, 3 mm	--	2	1	2	1	2	1	6	1,2
4.8 (suitable for welding)	M4, 4 mm	--	2	1,2	2	1,2	2	1,2	6	1,4
4.8 (suitable for welding)	M5, 5 mm	5 mm, M3	2	1,6	2	1,6	2	1,6	6	1,6
4.8 (suitable for welding)	M6, 6 mm	6 mm, M4	6	1,6	6	1,6	6	1,6	6	2
4.8 (suitable for welding)	M8, 7.1 mm	7.1 mm, M5	--	--	6	2	6	2	--	--
Material of workpiece: Galvanised steel (suitable for welding)										
4.8 (suitable for welding)	M3, 3 mm	--	6	1	6	1	6	1	2	1
4.8 (suitable for welding)	M4, 4 mm	--	6	1	6	1	6	1	2	1
4.8 (suitable for welding)	M5, 5 mm	5 mm, M3	3	1	3	1	6	1	2	1
4.8 (suitable for welding)	M6, 6 mm	6 mm, M4	3	1	3	1	6	1	2	1,2
4.8 (suitable for welding)	M8, 7.1 mm	7.1 mm, M5	--	--	--	--	--	--	3	1,2
Material of workpiece: Alloyed steel (suitable for welding)										
A2-50	M3, 3 mm	--	6	1,4	6	1,4	6	1,4	6	1,2
A2-50	M4, 4 mm	--	6	1,4	6	1,4	6	1,4	3	1,2
A2-50	M5, 5 mm	5 mm, M3	6	1,6	6	1,6	6	1,6	3	1,6
A2-50	M6, 6 mm	6 mm, M4	6	2	6	2	6	2	3	2
A2-50	M8, 7.1 mm	7.1 mm, M5	6	2	6	2	6	2	3	2
Material of workpiece: Alloyed steel (suitable for welding)										
CuZn37	M3, 3 mm	--	6	1	6	1	6	1	3	1
CuZn37	M4, 4 mm	--	6	1	6	1	6	1	3	1,2
CuZn37	M5, 5 mm	5 mm, M3	--	--	--	--	--	--	3	1,4
CuZn37	M6, 6 mm	6 mm, M4	--	--	--	--	--	--	3	1,6
CuZn37	M8, 7.1 mm	7.1 mm, M5	--	--	--	--	--	--	--	--
Material of workpiece: Aluminium										
AlMg3	M3, 3 mm	--	6 - 9	1,8	6 - 9	1,8	6 - 9	1,8	--	--
AlMg3	M4, 4 mm	--	6 - 9	2	6 - 9	2	6 - 9	2	--	--
AlMg3	M5, 5 mm	5 mm, M3	6 - 9	2,6 - 3	6 - 9	2,6 - 3	6 - 9	2,6 - 3	--	--
AlMg3	M6, 6 mm	6 mm, M4	6 - 9	3 - 3,2	6 - 9	3 - 3,2	6 - 9	3 - 3,2	--	--
AlMg3 ²⁾	M8, 7.1 mm ²⁾	7.1 mm, M5 ²⁾	6 - 9	4	6 - 9	4	6 - 9	3,4	--	--

¹⁾ to be checked by test weldings

²⁾ Due to the material characteristics of Aluminium and the corresponding limitations regarding the process stability a maximum stud diameter of 6 mm is recommended.



Std welding units		CD 1501 CDi 1502	CD 2301 CDi 2302	CD 3101 / CDi 3102 CDM 2401 CDMi 2402 CDM 3201 CDMi 3202 SCD 3201	SC-Mode without shielding gas					
Material of welding elements	Diameter of welding elements imperial (US)		Welding gun parameters ¹⁾ CA 08							
	PT, UT	IT	Spring force (scaling)	Lift (mm)	Spring force (scaling)	Lift (mm)	Spring force (scaling)	Lift (mm)	Spring force (scaling)	Lift (mm)
Material of workpiece: Mild steel (suitable for welding)										
4.8 (suitable for welding)	1/8"	#6-32	2	1	2	1	2	1	6	1,2
4.8 (suitable for welding)	5/32"	#8-32	2	1,2	2	1,2	2	1,2	6	1,4
4.8 (suitable for welding)	3/16"	#10-32	2	1,6	2	1,6	2	1,6	6	1,6
4.8 (suitable for welding)	1/4"	1/4-20	6	1,6	6	1,6	6	1,6	6	2
4.8 (suitable for welding)	5/16"	5/16-18	--	--	6	2	6	2	--	--
Material of workpiece: Galvanised steel (suitable for welding)										
4.8 (suitable for welding)	1/8"	#6-32	6	1	6	1	6	1	2	1
4.8 (suitable for welding)	5/32"	#8-32	6	1	6	1	6	1	2	1
4.8 (suitable for welding)	3/16"	#10-32	3	1	3	1	6	1	2	1
4.8 (suitable for welding)	1/4"	1/4-20	3	1	3	1	6	1	2	1,2
4.8 (suitable for welding)	5/16"	5/16-18	--	--	--	--	--	--	3	1,2
Material of workpiece: Alloyed steel (suitable for welding)										
A2-50	1/8"	#6-32	6	1,4	6	1,4	6	1,4	6	1,2
A2-50	5/32"	#8-32	6	1,4	6	1,4	6	1,4	3	1,2
A2-50	3/16"	#10-32	6	1,6	6	1,6	6	1,6	3	1,6
A2-50	1/4"	1/4-20	6	2	6	2	6	2	3	2
A2-50	5/16"	5/16-18	6	2	6	2	6	2	3	2
Material of workpiece: Alloyed steel (suitable for welding)										
CuZn37	1/8"	#6-32	6	1	6	1	6	1	3	1
CuZn37	5/32"	#8-32	6	1	6	1	6	1	3	1,2
CuZn37	3/16"	#10-32	--	--	--	--	--	--	3	1,4
CuZn37	1/4"	1/4-20	--	--	--	--	--	--	3	1,6
CuZn37	5/16"	5/16-18	--	--	--	--	--	--	--	--
Material of workpiece: Aluminium										
AlMg3	1/8"	#6-32	6 - 9	1,8	6 - 9	1,8	6 - 9	1,8	--	--
AlMg3	5/32"	#8-32	6 - 9	2	6 - 9	2	6 - 9	2	--	--
AlMg3	3/16"	#10-32	6 - 9	2,6 - 3	6 - 9	2,6 - 3	6 - 9	2,6 - 3	--	--
AlMg3	1/4"	1/4-20	6 - 9	3 - 3,2	6 - 9	3 - 3,2	6 - 9	3 - 3,2	--	--
AlMg3 ²⁾	5/16" ²⁾	5/16-18 ²⁾	6 - 9	4,0	6 - 9	4,0	6 - 9	3,4	--	--

¹⁾ to be checked by test weldings

²⁾ Due to the material characteristics of Aluminium and the corresponding limitations regarding the process stability a maximum stud diameter of 6 mm is recommended.

Bimetallic insulation pins

Std welding units		CD 1501 CDi 1502	CD 2301 CDi 2302	CD 3101 / CDi 3102			
Material of welding elements	Diameter of Bush metrisch in mm	Welding gun parameters ¹⁾ CA 08					
		Spring force (scaling)	Lift (mm)	Spring force (scaling)	Lift (mm)	Spring force (scaling)	Lift (mm)
Material of workpiece: Aluminium							
AlMg3	6	6 - 9	3 - 3.2	6 - 9	3 - 3.2	6 - 9	3 - 3.2

¹⁾ to be checked by test weldings

CD ground clips (single and double style)



For welding of ground clips (single and double style) we recommend setting the welding parameters for diameter M4.

Adjusting Lift



The adjustment piece for lift must not be turned by more than 360°.

Setting the lift to zero point

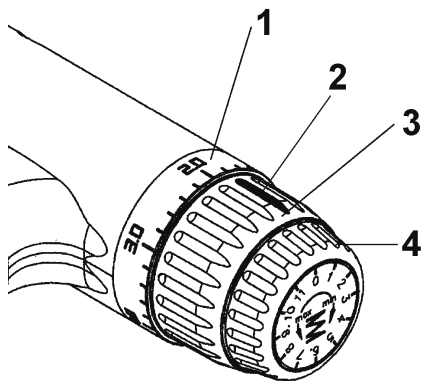

- 1 - End ring
- 2 - Marking
- 3 - Adjustment piece lift
- 4 - Adjustment piece spring force

- ◆ Place the welding gun perpendicularly onto the workpiece.
- ◆ Pull the adjustment piece for lift (3) to the rear out of the locking position.
- ◆ With the welding gun in contact with the workpiece, turn the adjustment piece for lift in clockwise direction until the welding piston allows no further movement in axial direction.
- ◆ Now turn the end ring (1) of the welding gun until the „0“ position is aligned with the marking (2) on the adjustment piece for lift.



The ignition tip of the welding element may have been damaged when the welding gun was adjusted.

We recommend not to use this welding element any more.

Adjusting the lift according to welding task

- ◆ Now turn the adjustment piece for lift in counter-clockwise direction to the selected lift (see table under point 10.3).

The lift can be adjusted in steps of 0.2 mm. (The empty space between 0 and 0.2 mm serves to mechanically balance out the lifting ring construction.)

- ◆ Now push the adjustment piece for lift forward again into the locking position.
- ◆ You can **reduce** the lift by turning the adjustment piece for lift **clockwise**.
- ◆ You can **increase** the lift by turning the adjustment piece for lift **counter-clockwise**.

Adjusting Spring Force



The adjustment piece for spring force must not be turned by more than 360°.

- ◆ Turn the adjustment piece for spring force only until you feel a noticeable resistance.
- ◆ Never turn the adjustment piece further with force, as otherwise mechanical parts of the welding gun may be damaged.

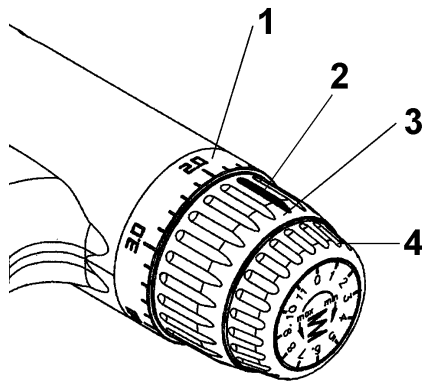

- 1 - End ring
- 2 - Marking
- 3 - Adjustment piece lift
- 4 - Adjustment piece spring force

- ◆ Turn the adjustment piece for spring force (4) up to the stop in „min“ direction. The position „0“ should be aligned with the marking (2) on the adjustment piece for lift (3).
- ◆ Now turn the adjustment piece for spring force to the selected value (see table under point 10.3).

You thus determine the insertion rate.



The scale on the adjustment piece for spring force does not correspond to any particular dimensions.

- ◆ You can **reduce** the insertion rate of the welding piston by turning the adjustment piece for spring force **clockwise**.
- ◆ You can **increase** the insertion rate of the welding piston by turning the adjustment piece for spring force **counter-clockwise**.



11 Welding



- ◆ Work according to the *original operating manual of the HBS power unit.*



Danger if used other than for the intended purpose

- ◆ Use the welding gun only for CD stud welding or short cycle drawn arc welding and only in combination with power units from manufacturer:



HBS Bolzenschweiss-Systeme GmbH & Co. KG

Felix-Wankel-Strasse 18
85221 Dachau
GERMANY



- ◆ Always check with the operating manual of your power unit whether this welding gun may be used.

12 Troubleshooting







Danger from insufficiently qualified operating personnel

- ◆ Carry out only the work described here on your stud welding unit or stud welding gun.
- ◆ Repairs may only be carried out by appropriately qualified personnel.
- ◆ Inform your dealer or your maintenance department.

Fault	Possible cause	Fault localisation	Fault remedy	Performance
Welding elements not firmly attached	Wrong welding parameters selected	Check adjusted parameters on stud welding unit Check spring force of welding gun Check lift of welding gun	Change adjusted parameters Change adjusted parameters Change adjusted parameters Clean or replace *)	Trained personnel Trained personnel Trained personnel Qualified specialists
	Insertion speed of welding element too low	Check welding piston and linear bearing for ease of movement *)		Qualified specialists
Burning marks at the welding element	Chuck defective	Check chuck for possible defects	Replace chuck	Trained personnel
	Lamellas of chuck are not pretensioned	O-rings existing? Check o-rings for possible defects	Replace o-rings	Trained personnel
Welding gun does not weld	Control cable defective (with present contact signal on stud welding unit)	Check control cable for electrical flow at control cable sleeve (Pin 3 and 4) with pressed welding gun trigger *)	In case of no flow: Replace control cable *)	Qualified specialists
	Micro switch defective (with present contact signal on stud welding unit)	Check micro switch for electrical flow with pressed welding gun trigger *)	In case of no flow: Replace micro switch *)	Qualified specialists
	Welding current cable defective (no contact signal on stud welding unit)	Check, whether welding current cable is connected to stud welding unit in a technically correct way Check welding current cable for electrical flow *)	Connect welding current cable In case of no flow : Replace welding current cable and/or connecting cable *)	Trained personnel Qualified specialists



Fault	Possible cause	Fault localisation	Fault remedy	Performance
Welding gun does not weld	Ground connection defective (no contact signal on stud welding unit)	Check, whether ground cable is connected to workpiece in a technically correct way Check ground cable for electrical flow *)	Connect ground cable In case of no flow: Replace ground cable *)	Trained personnel Qualified specialists
	Stud welding unit defective	Follow the instructions of the connected stud welding unit	Repair required	Factory service or authorised agencies
Welding gun does not lift, in spite of  ,  and 	No lift adjusted	Check adjusted parameters on welding gun	Change adjusted parameters	Trained personnel
	Short circuit of magnetic circuit of the welding gun	Measure resistance value at control cable connector (18 Ω to 22 Ω) between Pin 1 and Pin 2 *)	Replace control cable connector, control cable and solenoid *)	Qualified specialists
No  display	Solenoid defective	Measure solenoid (18 Ω to 22 Ω *)	Replace solenoid *)	Qualified specialists
	Magnetic circuit interrupted	Measure resistance value at control cable connector (18 Ω to 22 Ω) between Pin 1 and Pin 2 *)	Replace solenoid or control cable *)	Qualified specialists



Work marked with *) may only be carried out by qualified electricians!

- ◆ Please contact our Service department if none of the measures described remedies the situation.
- ◆ Please use the form „Service & Repair“ in the annex to send in the stud welding unit or stud welding gun.

13 Maintenance and Care



Electric shock hazard

- ◆ Never perform maintenance and service work on your stud welding gun while it is connected to the stud welding unit
- ◆ Prior to this disconnect the stud welding gun from the stud welding unit.



Danger from insufficiently qualified operating personnel

- ◆ Carry out only the work described here on your stud welding gun.
- ◆ Repairs may only be carried out by appropriately qualified personnel.
- ◆ Inform your dealer or your maintenance department.

13.1 Cleaning

- ◆ Clean the casing of your stud welding gun with a slightly damp washcloth, when necessary.



- ◆ **Do not use solvents for cleaning.**

These may damage plastic components.

13.2 Inspection and Tests

- ◆ Inspect the chuck before every use.
- ◆ Replace the chuck if you discover burning marks on the welding element and/or on the chuck.
- ◆ Work here in accordance with *point 10.1 „Adjusting the Chuck“* in this manual.
- ◆ Before every use, inspect the bellows on the front part of the welding gun for proper seating and/or damage.



- ◆ **Never work with damaged or incorrectly seated bellows.**

This will contribute to a long service life of your welding gun.

- ◆ Inform your dealer or maintenance department if you discover any damage.

- ◆ Before every use, check that the type designations and adjustment aids on the welding gun are still legible.
- ◆ Clean the type plates in the event of soiling.
- ◆ Replace any type plates that are damaged or no longer legible.

14 Storage

- ◆ Store the stud welding gun in a safe and dust-free location when not in use.
- ◆ Protect the stud welding gun from moisture and metallic contamination.



- ◆ Store the stud welding gun only under the following ambient conditions.

Storage temperature:

-5 °C to +50 °C (23 °F to 122 °F)

Relative humidity:

0 % - 50 % at +40 °C (104 °F)

0 % - 90 % at +20 °C (68 °F)

15 Disposal

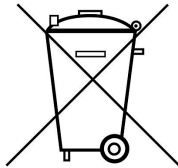

- ◆ Dispose of the stud welding gun only via the manufacturer or a specialist disposal company.
- ◆ Never dispose of the stud welding gun in the domestic refuse.



Declaration of Incorporation of partly completed Machinery

to Directive 2006/42/EC, Annex II 1 B
(Original Declaration of Incorporation)

Herewith the manufacturer

HBS Bolzenschweiss-Systeme GmbH & Co. KG
Felix-Wankel-Strasse 18
P.O. Box 13 46
85221 Dachau
GERMANY
Phone +49 8131 511-0
Fax +49 8131 511-100

declares for the following product

Machine information: Welding gun
Type: CA 08
Order No: 92-20-255
Serial No: 92-20-255/162XXXX
Year of manufacture: 2016

that the following essential requirements of the above mentioned Directive – including changes to the Directive to be applied at the moment of this declaration – were applied and fulfilled:

Annex I, Article 1, 1.1.2, 1.1.3, 1.1.5, 1.1.6, 1.1.7, 1.2.1, 1.2.2, 1.2.3, 1.2.4.1, 1.2.6, 1.3.1, 1.3.2, 1.3.3, 1.3.4, 1.3.7, 1.3.8, 1.3.9, 1.4.1, 1.4.2.1, 1.5.1, 1.5.2, 1.5.4, 1.5.5, 1.5.6, 1.5.8, 1.5.10, 1.5.11, 1.5.15, 1.5.16, 1.6.1, 1.6.2, 1.6.3, 1.6.4, 1.7.1.1, 1.7.2, 1.7.3, 1.7.4,

that special technical documentation was compiled in accordance with Part B of Annex VII of the above mentioned regulation and will be transmitted, in response to a reasoned request by the national authorities as follows:

The above mentioned documents will be transmitted by e-mail as a data file in German language.

that this partly completed machinery must not be put into service until the final machinery into which it is to be incorporated has been declared in conformity with the provisions of the Directive, where appropriate.

that this incomplete machine complies with corresponding regulations of the following additional EU Directives, including any changes to be applied at the moment of this declaration:

„Electromagnetic compatibility“ 2014/30/EU
Protection targets of the low voltage regulation were kept to appendix I, no. 1.5.1 of the machine regulation.

Persons who are based in the European community and who are authorised to compile the technical documentation:

Name: Heike Otto Address: see manufacturer

Dachau, 02.01.2016
Place of issue, Date



Gregor Gröger (Geschäftsführer HBS)

Service & Support

With the return please attach a copy of the filled out form together with the repair number given by HBS! Repairs without repair number will not be processed.

Repair number
(given by HBS)











Company: _____
 Name / Surname: _____
 Street: _____
 City, State and ZIP/Postcode: _____
 Country: _____
 Phone & Fax: _____
 E-mail address: _____

Stud welding unit / stud welding gun
 type of model: _____
 Serial number: _____
 Date of purchase: _____
 Purchased at distributor: _____

Detailed descriptions of errors: _____

Service & Support may be done up to the value of EUR _____ Yes No
 without quotation:
 Could you find any damage / burn marks
 on the cables: Yes No
 on chucks: Yes No
 Are all plug and screw connections tightly fastened *: Yes No
 Are there any burn marks on plug or screw connections: Yes No
 Is there any other visual damage (e.g. cracks, dents): Yes No
 Have you checked the fuses: Yes No

Default on the display of the stud welding unit:

ARC / IT					CD / CDM / SC					
										 **

Which LED's are illuminated (please mark with a cross)?

Please e-mail or fax this form to post@hbs-info.de or fax: +49 8131 511-100.
 In case a repair is necessary a repair number will be given!

* See also operating manual chapter „Connection“
 ** Doesn't light when using a contact welding gun

Index

A

accessories	12
adjustment piece lift	26
adjustment piece spring force	27
airborne particulates	7
automatic welding head	11

B

bang	7
basic configuration	12

C

capacitor	11
chuck, adjusting	18
chuck, mounting	21
cleaning	31
clothing, non-flammable	8

D

danger from incorrect use	6
Declaration of Incorporation	34
disposal	33

E

ear protection	9
electrical hazards	9
electromagnetic fields	9

F

fire extinguisher	7
fire hazard	7
form „Service & Support“	30, 35
full-ear hearing protection	8
fumes, harmful to health	7

G

glossary	11
goggles with visor	8
graduated ring	16

H

hazards for the machine	9
hazards for the operator	9
heart pacemaker	7, 9
helmet	8

I

intended use	14, 28
------------------------	--------

L

lift	22
lift adjustment	16, 26
light arc	11

M

maintenance and care	31
--------------------------------	----

O

operating manual	12
----------------------------	----

P

protective apron	8
protective equipment	8
protective equipment, personal	9
protective gloves	8

R

rectifier	11
retaining nut	16

S

safety goggles	9
safety goggles with sight glass	8
safety precautions	6
scope of supply	12
serial number	16
spring force	22
spring force adjustment	16, 27
storage	33
storage temperature	33
stud feeder	11
stud welding gun	11
stud welding machine	11
stud welding unit	11
symbols used	9

T

tripod legs	16
troubleshooting	29
type plate	16

W

warranty entitlement	15
welding element	11, 14
welding gun, design	16
welding gun trigger	16
welding parameters	11, 22
workpiece	11

HBS Bolzenschweiss-Systeme GmbH & Co. KG
Felix-Wankel-Strasse 18 • 85221 DACHAU • GERMANY
Phone +49 8131 511-0 • Fax +49 8131 511-100 • E-mail post@hbs-info.com

www.hbs-info.com